

**Surface Mount General Purpose Silicon Rectifiers**
**Reverse Voltage - 50 to 1000 V**
**Forward Current - 1 A**
**FEATURES**

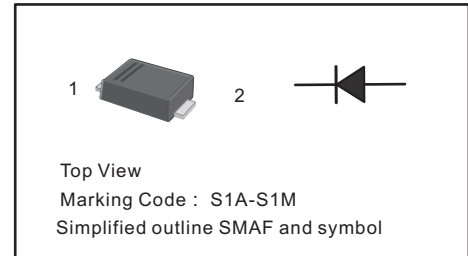
- For surface mounted applications
- Low profile package
- Glass Passivated Chip Junction
- Easy to pick and place
- Lead free in comply with EU RoHS 2011/65/EU directives

**MECHANICAL DATA**

- Case: SMAF
- Terminals: Solderable per MIL-STD-750, Method 2026
- Approx. Weight: 27mg / 0.00095oz

**PINNING**

PIN	DESCRIPTION
1	Cathode
2	Anode


**Maximum Ratings and Electrical characteristics**

Ratings at 25 °C ambient temperature unless otherwise specified.

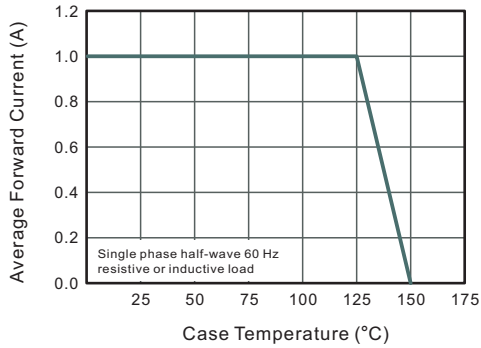
Single phase half-wave 60 Hz, resistive or inductive load, for capacitive load current derate by 20 %.

Parameter	Symbols	S1AF	S1BF	S1DF	S1GF	S1JF	S1KF	S1MF	Units
Maximum Repetitive Peak Reverse Voltage	$V_{RRM}$	50	100	200	400	600	800	1000	V
Maximum RMS voltage	$V_{RMS}$	35	70	140	280	420	560	700	V
Maximum DC Blocking Voltage	$V_{DC}$	50	100	200	400	600	800	1000	V
Maximum Average Forward Rectified Current at $T_c = 125\text{ °C}$	$I_{F(AV)}$	1							A
Peak Forward Surge Current 8.3 ms Single Half Sine Wave Superimposed on Rated Load	$I_{FSM}$	30							A
Maximum Instantaneous Forward Voltage at 1 A	$V_F$	1.1							V
Maximum DC Reverse Current $T_a = 25\text{ °C}$ at Rated DC Blocking Voltage $T_a = 125\text{ °C}$	$I_R$	5 50							$\mu A$
Typical Junction Capacitance <sup>(1)</sup>	$C_j$	15							pF
Typical Thermal Resistance <sup>(2)</sup>	$R_{\theta JA}$ $R_{\theta JC}$	80 27							$^{\circ}C/W$
Operating and Storage Temperature Range	$T_j, T_{stg}$	-55 ~ +150							$^{\circ}C$

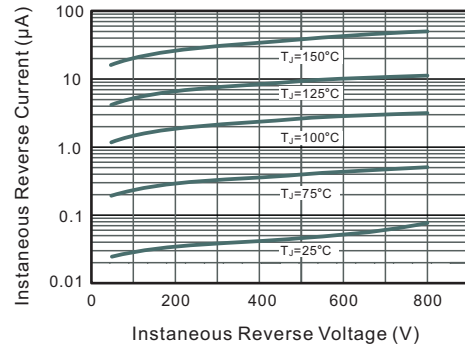
( 1 ) Measured at 1 MHz and applied reverse voltage of 4 V D.C

( 2 ) P.C.B. mounted with 2.0" X 2.0" (5 X 5 cm) copper pad areas.

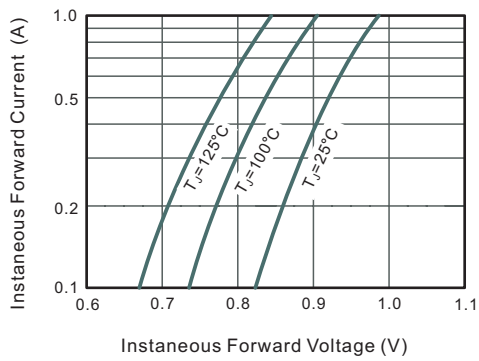
**Fig.1 Forward Current Derating Curve**



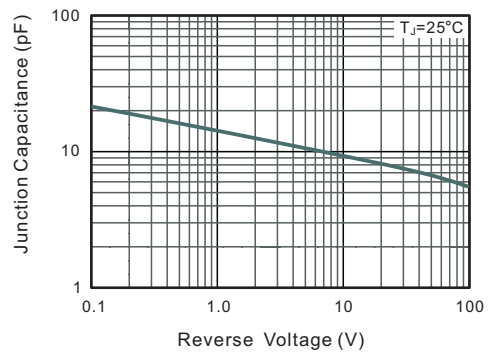
**Fig.2 Typical Instantaneous Reverse Characteristics**



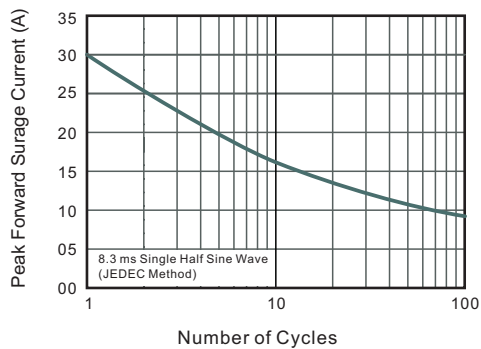
**Fig.3 Typical Forward Characteristic**



**Fig.4 Typical Junction Capacitance**

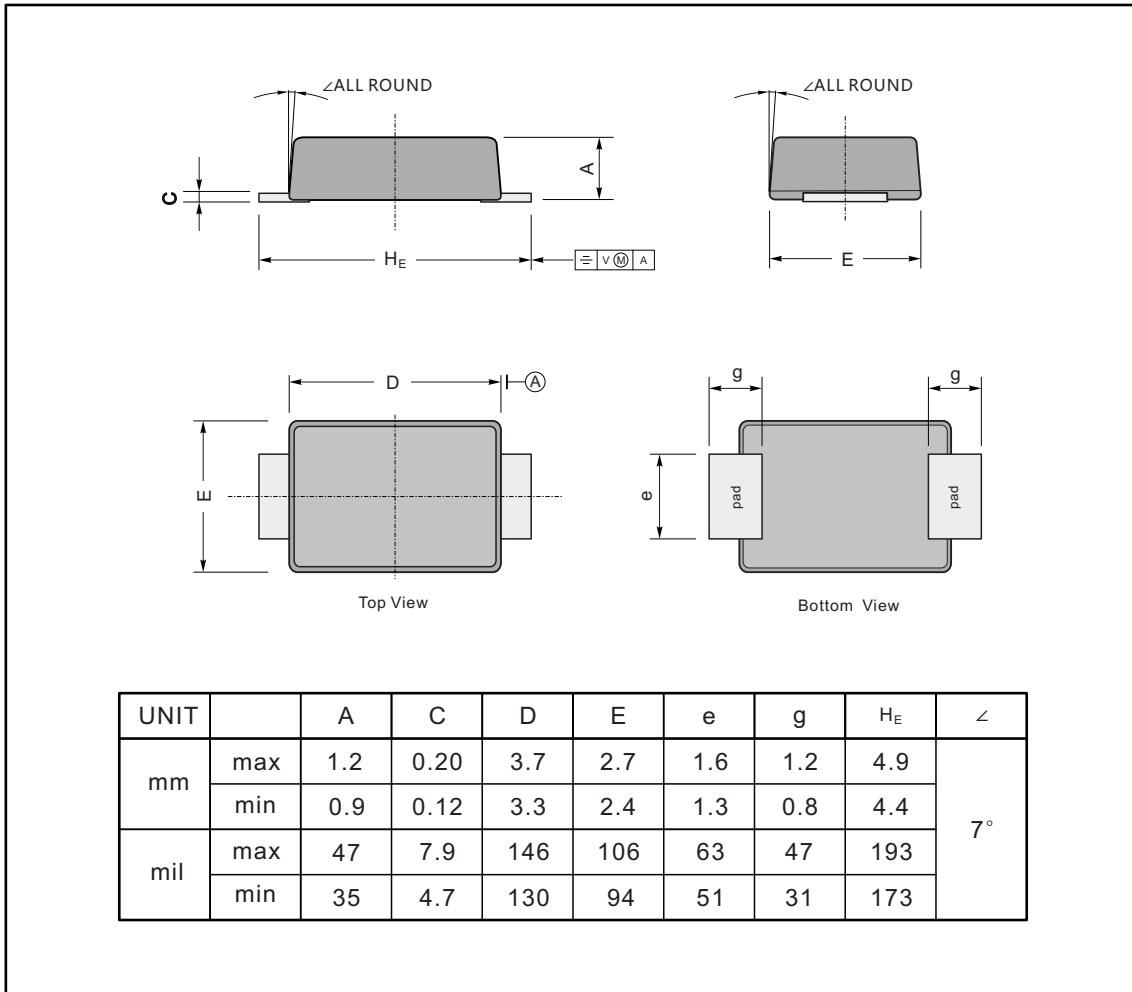
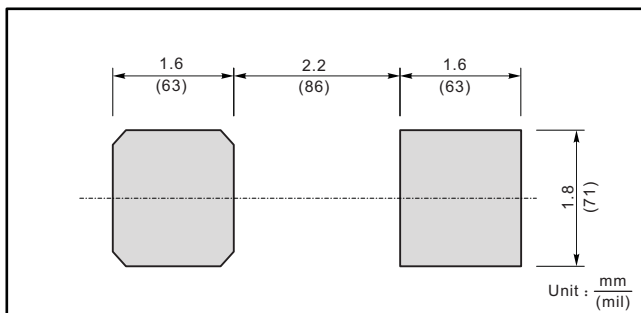


**Fig.5 Maximum Non-Repetitive Peak Forward Surge Current**



**PACKAGE OUTLINE**

Plastic surface mounted package; 2 leads

**SMAF**

**The recommended mounting pad size**

**Marking**

Type number	Marking code
S1AF	S1A
S1BF	S1B
S1DF	S1D
S1GF	S1G
S1JF	S1J
S1KF	S1K
S1MF	S1M