

-40V P-Channel Enhancement Mode MOSFET

Description

The 15P04D uses advanced trench technology to provide excellent $R_{DS(ON)}$, low gate charge and operation with gate voltages as low as 4.5V. This device is suitable for use as a Battery protection or in other Switching application.

General Features

$V_{DS} = -40V$ $I_D = -15A$

$R_{DS(ON)} < 32m\Omega$ @ $V_{GS} = -10V$

Application

Battery protection

Load switch

Uninterruptible power supply

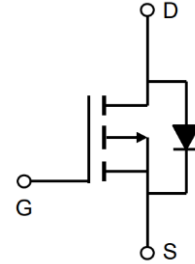

Package Marking and Ordering Information

Product ID	Pack	Marking	Qty(PCS)
15P04D	TO-252-3L	15P04D YYY	2500

Absolute Maximum Ratings ($T_C=25^\circ C$ unless otherwise noted)

Symbol	Parameter	Rating	Units
V_{DS}	Drain-Source Voltage	-40	V
V_{GS}	Gate-Source Voltage	± 20	V
$I_D@T_C=25^\circ C$	Continuous Drain Current, $-V_{GS}$ @ $-10V^1$	-15	A
$I_D@T_C=100^\circ C$	Continuous Drain Current, $-V_{GS}$ @ $-10V^1$	-11	A
I_{DM}	Pulsed Drain Current ²	-54	A
EAS	Single Pulse Avalanche Energy ³	40.9	mJ
I_{AS}	Avalanche Current	-28.6	A
$P_D@T_C=25^\circ C$	Total Power Dissipation ⁴	35	W
T_{STG}	Storage Temperature Range	-55 to 150	$^\circ C$
T_J	Operating Junction Temperature Range	-55 to 150	$^\circ C$
$R_{\theta JA}$	Thermal Resistance Junction-Ambient ¹	62	$^\circ C/W$
$R_{\theta JC}$	Thermal Resistance Junction-Case ¹	3.6	$^\circ C/W$

-40V P-Channel Enhancement Mode MOSFET
Electrical Characteristics (T_J=25°C, unless otherwise noted)

Symbol	Parameter	Conditions	Min.	Typ.	Max.	Unit
BVDSS	Drain-Source Breakdown Voltage	V _{GS} =0V, I _D =-250uA	-40	-47	---	V
ΔBVDSS/ΔT _J	BV _{DSS} Temperature Coefficient	Reference to 25°C, I _D =-1mA	---	-0.02	---	V/°C
RDS(ON)	Static Drain-Source On-Resistance ²	V _{GS} =-10V, I _D =-8A	---	27	32	mΩ
		V _{GS} =-4.5V, I _D =-4A	---	39	46	
VGS(th)	Gate Threshold Voltage	V _{GS} =V _{DS} , I _D =-250uA	-1.0	-1.6	-2.5	V
ΔVGS(th)	V _{GS(th)} Temperature Coefficient		---	3.72	---	V/°C
IDSS	Drain-Source Leakage Current	V _{DS} =-32V, V _{GS} =0V, T _J =25°C	---	---	1	uA
		V _{DS} =-32V, V _{GS} =0V, T _J =55°C	---	---	5	
IGSS	Gate-Source Leakage Current	V _{GS} =±20V, V _{DS} =0V	---	---	±100	nA
gfs	Forward Transconductance	V _{DS} =-5V, I _D =-8A	---	10.7	---	S
Q _g	Total Gate Charge (-4.5V)	V _{DS} =-15V, V _{GS} =-4.5V, I _D =-1A	---	11.5	---	nC
Q _{gs}	Gate-Source Charge		---	3.5	---	
Q _{gd}	Gate-Drain Charge		---	3.3	---	
Td(on)	Turn-On Delay Time	V _{DD} =-15V, V _{GS} =-10V, R _G =3.3Ω, I _D =-1A	---	22	---	ns
T _r	Rise Time		---	15.7	---	
Td(off)	Turn-Off Delay Time		---	59	---	
T _f	Fall Time		---	5.5	---	
Ciss	Input Capacitance	V _{DS} =-15V, V _{GS} =0V, f=1MHz	---	1415	---	pF
Coss	Output Capacitance		---	134	---	
Crss	Reverse Transfer Capacitance		---	102	---	
IS	Continuous Source Current ^{1,5}	V _G =V _D =0V, Force Current	---	---	-27	A
ISM	Pulsed Source Current ^{2,5}		---	---	-54	A
VSD	Diode Forward Voltage ²	V _{GS} =0V, I _S =-1A, T _J =25°C	---	---	-1.2	V

Note :

- 1、The data tested by surface mounted on a 1 inch 2 FR-4 board with 2OZ copper.
- 2、The data tested by pulsed, pulse width ≅ 300us, duty cycle ≅ 2%
- 3、The EAS data shows Max. rating. The test condition is V_{DD}=-25V, V_{GS}=-10V, L=0.1mH, I_{AS}=-28.6A
- 4、The power dissipation is limited by 150°C junction temperature
- 5、The data is theoretically the same as I_D and I_{DM}, in real applications, should be limited by total power dissipation

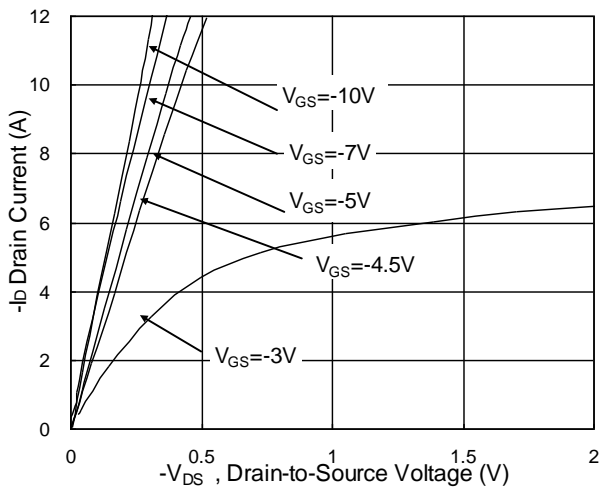
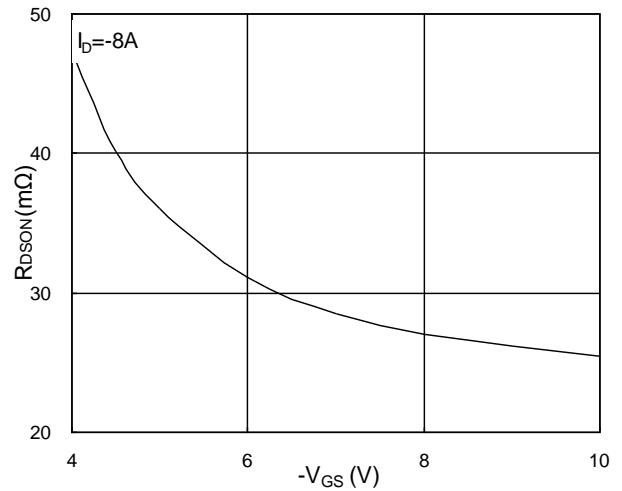
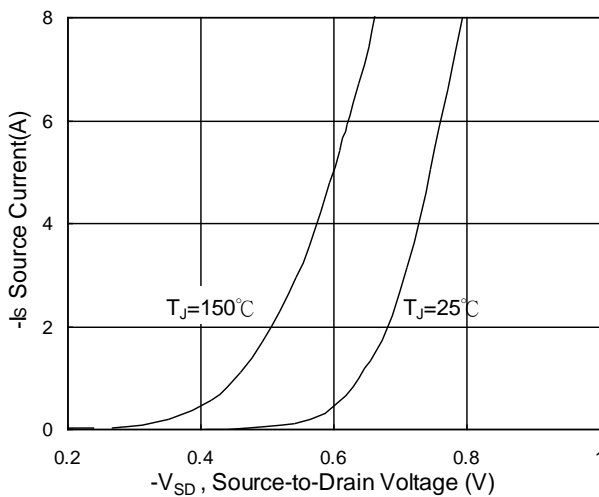
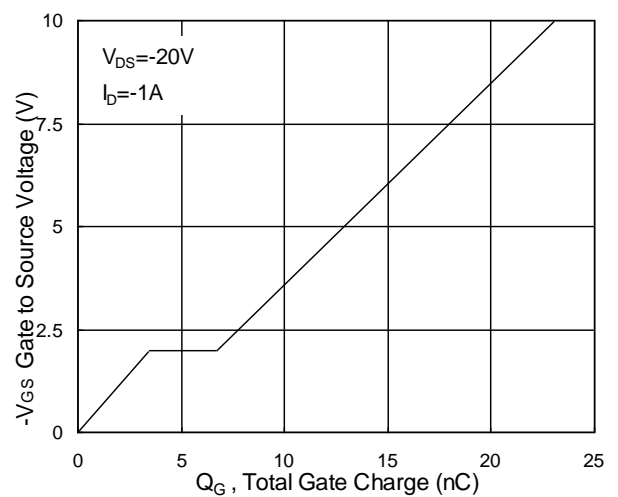
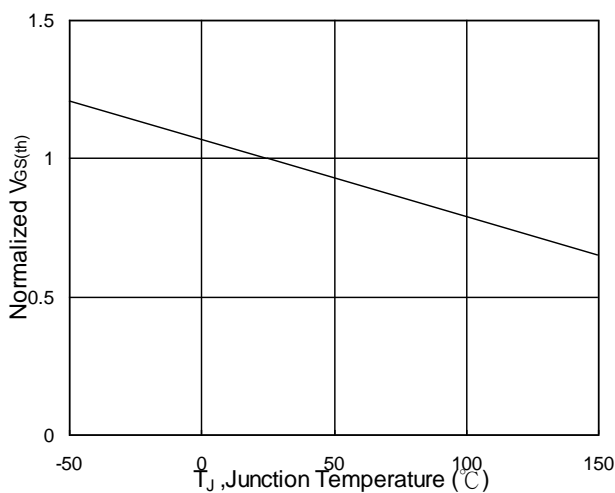
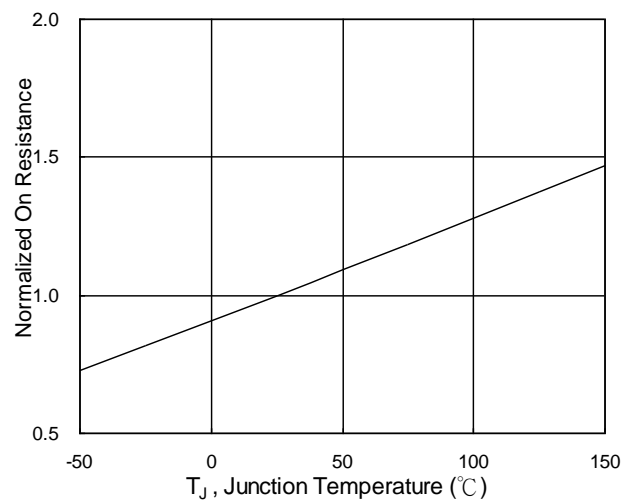
-40V P-Channel Enhancement Mode MOSFET
Typical Characteristics

Fig.1 Typical Output Characteristics

Fig.2 On-Resistance v.s Gate-Source

Fig.3 Forward Characteristics Of Reverse

Fig.4 Gate Charge Characteristics

Fig.5 Normalized $V_{GS(th)}$ v.s T_J

Fig.6 Normalized $R_{DS(on)}$ v.s T_J

-40V P-Channel Enhancement Mode MOSFET

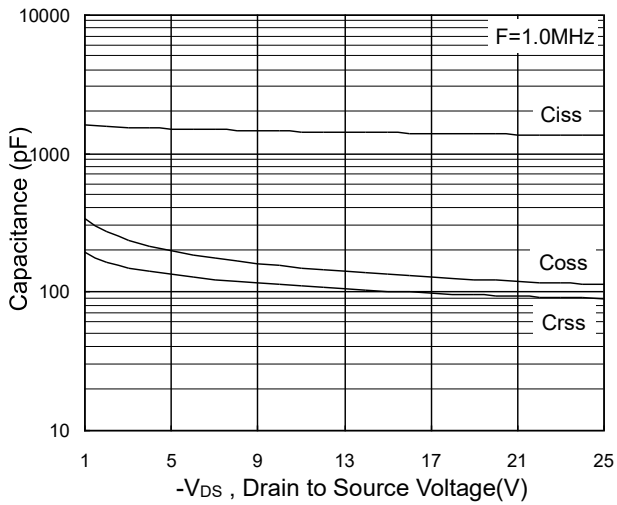

Fig.7 Capacitance

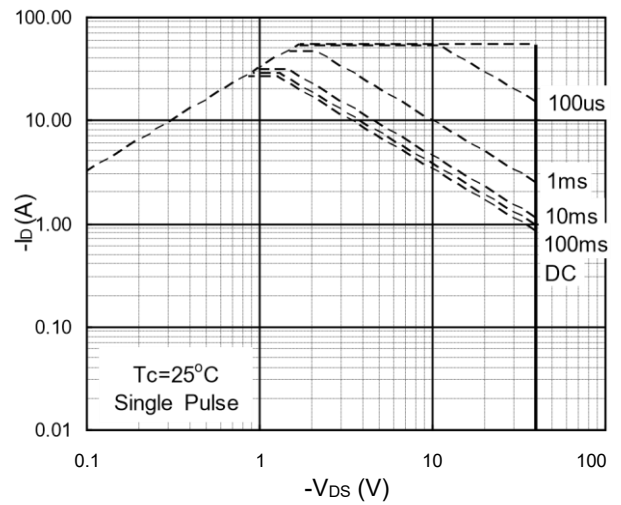

Fig.8 Safe Operating Area

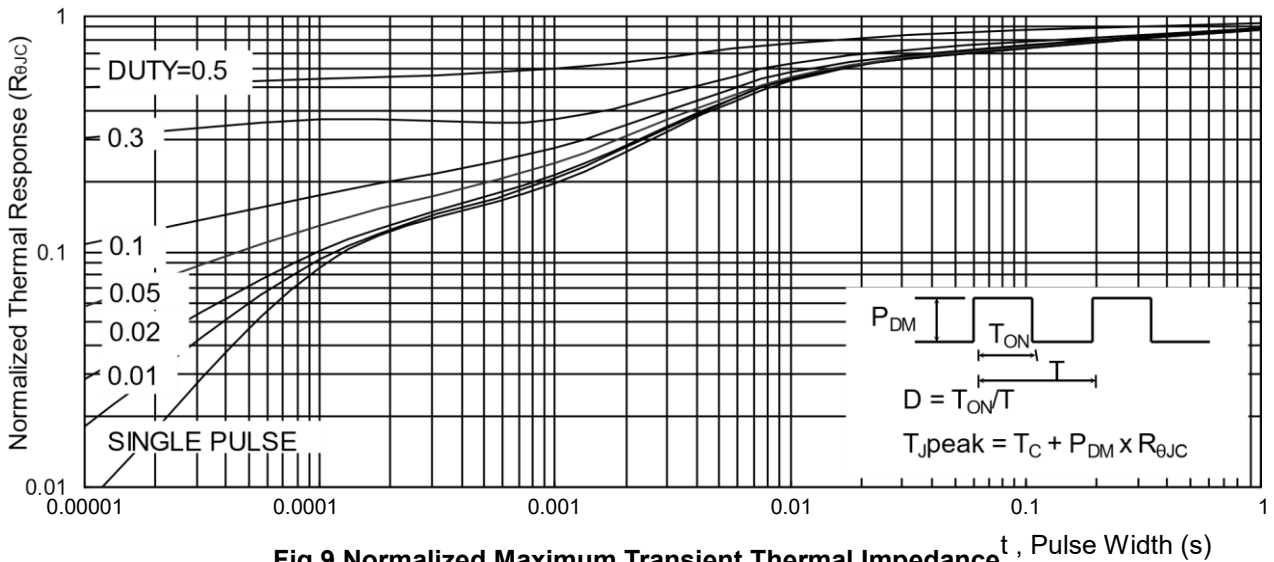

Fig.9 Normalized Maximum Transient Thermal Impedance

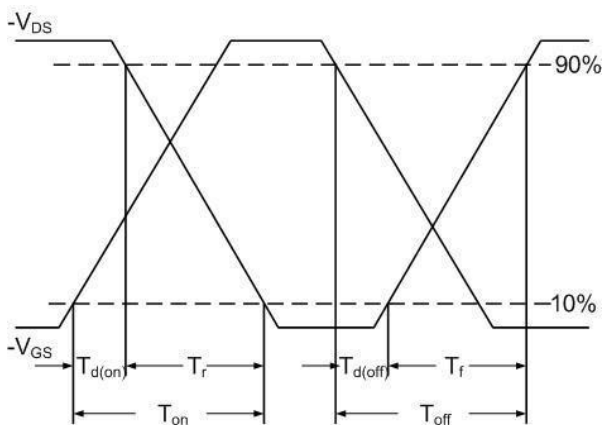

Fig.10 Switching Time Waveform

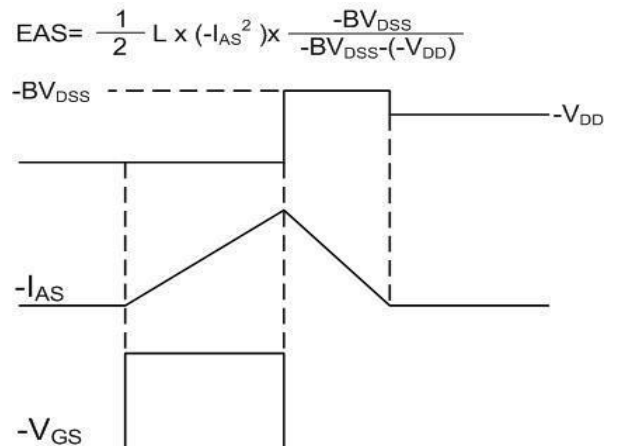
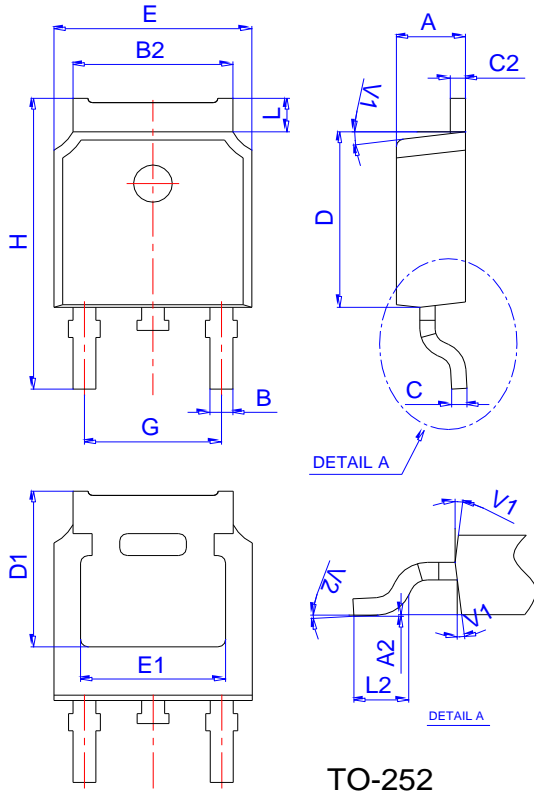
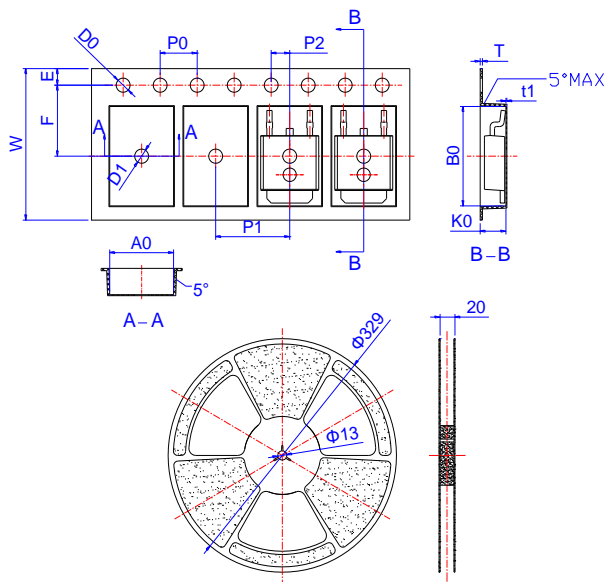

Fig.11 Unclamped Inductive Waveform

Package Mechanical Data

Ref.	Dimensions					
	Millimeters			Inches		
	Min.	Typ.	Max.	Min.	Typ.	Max.
A	2.10		2.50	0.083		0.098
A2	0		0.10	0		0.004
B	0.66		0.86	0.026		0.034
B2	5.18		5.48	0.202		0.216
C	0.40		0.60	0.016		0.024
C2	0.44		0.58	0.017		0.023
D	5.90		6.30	0.232		0.248
D1	5.30REF			0.209REF		
E	6.40		6.80	0.252		0.268
E1	4.63			0.182		
G	4.47		4.67	0.176		0.184
H	9.50		10.70	0.374		0.421
L	1.09		1.21	0.043		0.048
L2	1.35		1.65	0.053		0.065
V1		7°			7°	
V2	0°		6°	0°		6°

Reel Specification-TO-252

Ref.	Dimensions					
	Millimeters			Inches		
	Min.	Typ.	Max.	Min.	Typ.	Max.
W	15.90	16.00	16.10	0.626	0.630	0.634
E	1.65	1.75	1.85	0.065	0.069	0.073
F	7.40	7.50	7.60	0.291	0.295	0.299
D0	1.40	1.50	1.60	0.055	0.059	0.063
D1	1.40	1.50	1.60	0.055	0.059	0.063
P0	3.90	4.00	4.10	0.154	0.157	0.161
P1	7.90	8.00	8.10	0.311	0.315	0.319
P2	1.90	2.00	2.10	0.075	0.079	0.083
A0	6.85	6.90	7.00	0.270	0.271	0.276
B0	10.45	10.50	10.60	0.411	0.413	0.417
K0	2.68	2.78	2.88	0.105	0.109	0.113
T	0.24		0.27	0.009		0.011
t1	0.10			0.004		
10P0	39.80	40.00	40.20	1.567	1.575	1.583